

TOP VIEW

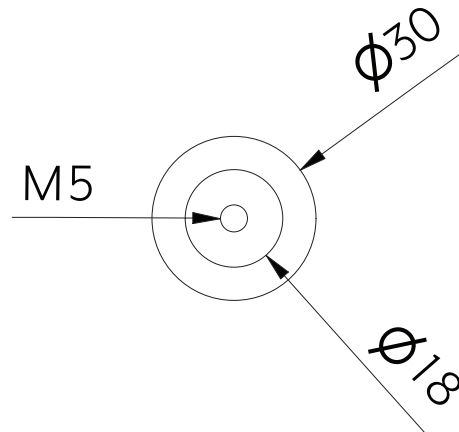

BOTTOM VIEW

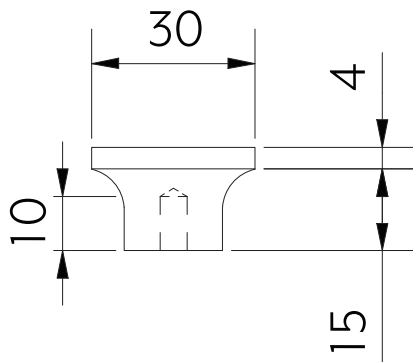

SIDE VIEW

DISCLAIMER: IF WANTING TO PAINT OR STAIN, PULL WILL REQUIRE SEALING.

Note: Dimensions are nominal measurements only

SPECIFICATIONS	
RECOMMENDED USE	Domestic
CONSTRUCTION	Ash wood
MOUNTING HARDWARE INCLUDED	Yes
SCREW / BOLT TYPE	M4*25mm
MOUNTS FROM	Front
HOLE DISTANCE	N/A

CABINETY HANDLE INSTALLATION GUIDE



Note: This product must be installed by a licensed tradesperson.
This is a general installation guide - there are many factors that are involved that can alter the installation method.

1. Mark out the desired position for handle on both sides of door/drawer panel.
2. Drill prescribed holes through door/drawer panel for handle fixings.

Note: Gauge drill bit using hole sizes in template.

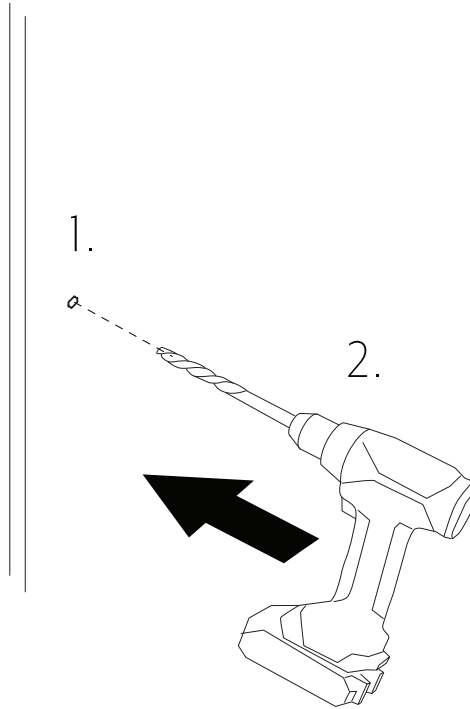

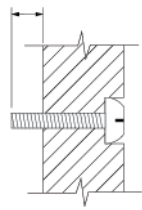

*Please Note

Your carpenter may need to countersink the provided bolts (shown) or provide alternative ones to fit your cabinetry.

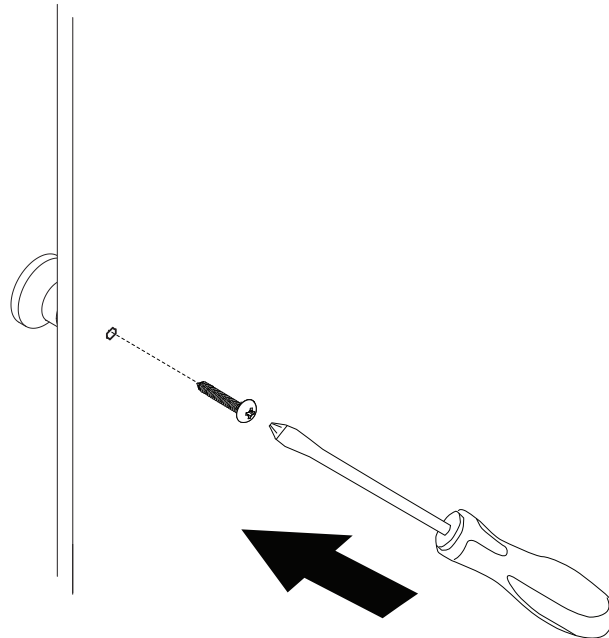

2. Using a Phillips head screwdriver fix screws into handle.



IN THE BOX		
	1x Handle	1x Screws