



IN WALL PROGRESSIVE MIXER BODY



INSTALLATION GUIDE

Note: This product must be installed by a licensed plumber.
This is a general installation guide - there are many factors that are involved that can alter the installation method.

Note: Handle not included with in wall mixer body.

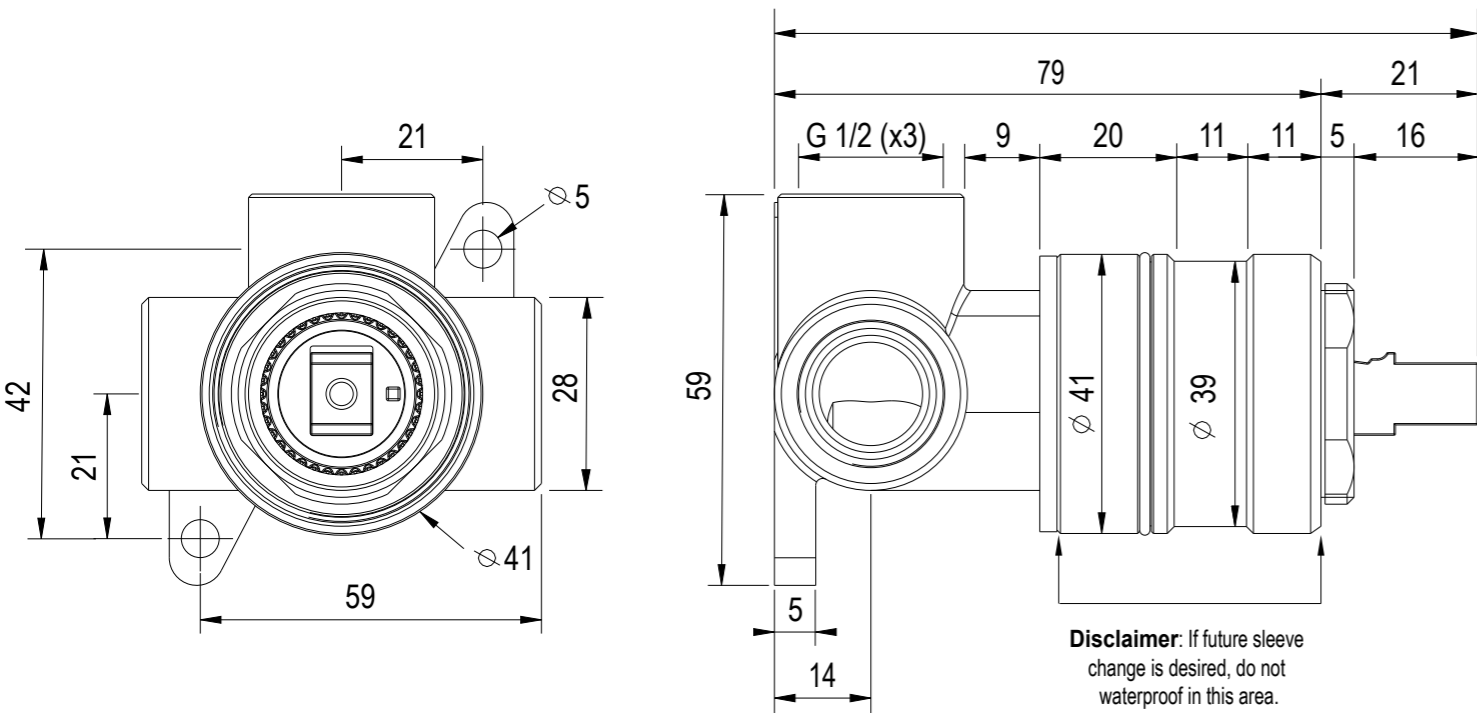

1 Fasten screws to secure the shower mixer assembly in place.

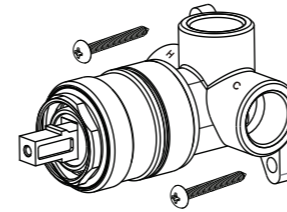

2 Attach water supply and water outlet. TEST AND CHECK FOR LEAKS

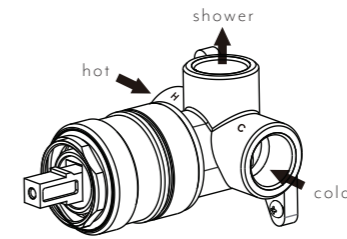

3 Create a 45mm round hole in cement sheet and tiles. Push the sleeve over the body until it is as far back as possible. Screw the dome onto the brass fitting and tighten

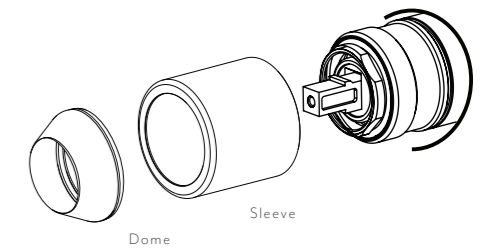

Please ensure that the hole is big enough to allow for the sleeve to slide on at fit-off stage

4 Assemble the plate and fix it in place.

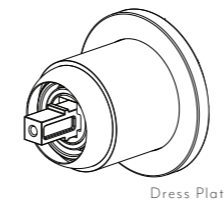

5 Place the handle onto the fitting. Fasten the grub screw firmly with the allen key

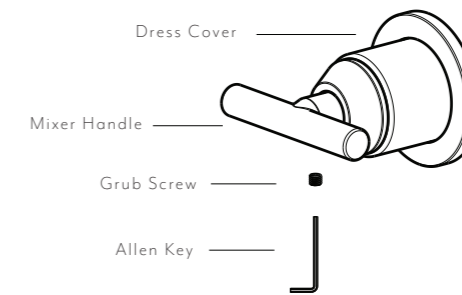

PROGRESSIVE MIXER OPERATION

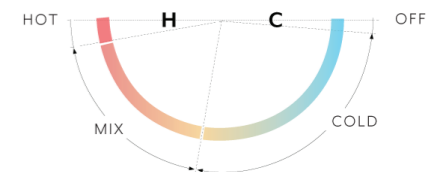

Note: Handle not included with inwall mixer body

Note: Dimensions are nominal measurements only

SPECIFICATIONS

RECOMMENDED USE

Domestic

CONSTRUCTION

Solid Brass

WARRANTY

Structure: 25 years | Finish: 5 years

Disclaimer: Products in this specification manual must by regulation be installed by licensed and registered trade people. The manufacturer/distributor reserves the right to vary specifications or delete models from their range without prior notification. Dimensions are nominal measurements only. Dimensions and set-outs listed are correct at time of publication however the manufacturer/distributor takes no responsibility for printing errors. All ABI Products are designed in Australia. Copyright ABI Interiors Pty Ltd 2021.

WHAT'S IN THE BOX

EXPLODED VIEW

- Item Description Code
- 1-2 Body
- 3 Rubber Ring
- 4 Cartridge
- 5 Locking Nut
- 6 Allen Key
- 7 Protective Case
- 8 Fixing Screws

