

Note: Dimensions are nominal measurements only

SPECIFICATIONS

RECOMMENDED USE

Domestic

PRESSURE RATING

Recommended minimum working pressure 0.2 Bar
Recommended maximum working pressure 5 Bar
Hot and cold water inlet pressure should be equal

TEMPERATURE RATING

Maximum continuous working temperature 75°C
If the water temperature exceeds 75°C, an approved tempering valve must be fitted

SUITABLE HOT WATER UNITS

Storage tank: Yes
Continuous Flow: Yes
Gravity Feed: Suitable

STANDARDS

Nominal Flow Rate(5.5 L/M)
WRAS approved

WARRANTY

Structure: 25 years | Finish: 5 years | Cartridge: 10 years

Disclaimer: Products in this specification manual must by regulation be installed by licensed and registered trade people. The manufacturer/distributor reserves the right to vary specifications or delete models from their range without prior notification. Dimensions are nominal measurements only. Dimensions and set-outs listed are correct at time of publication however the manufacturer/distributor takes no responsibility for printing errors. All ABI Products are designed in Australia. Copyright ABI Interiors 2019.

INSTALLATION GUIDE

Note: This product must be installed by a licensed tradesperson. This is a general installation guide - there are many factors that are involved that can alter the installation method.

Note: Flow restrictor to be installed when using this product over a basin and paired with a spout. Flow restrictors are provided with the spout

1 Fasten screws to secure the shower mixer assembly in place.

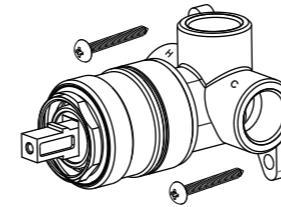

2 Attach water supply and water outlet. TEST AND CHECK FOR LEAKS

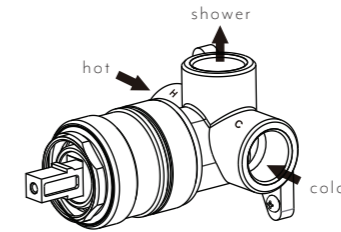

3 Create a 45mm round hole in cement sheet and tiles

Push the sleeve over the body until it is as far back as possible. Screw the dome onto the brass fitting and tighten

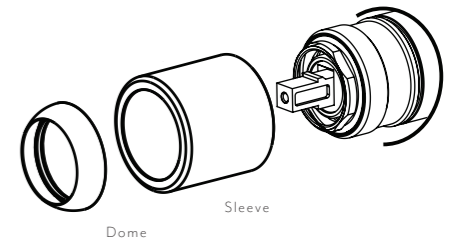

Please ensure that the hole is big enough to allow for the sleeve to slide on at fit-off stage

4 Assemble the plate and fix it in place.

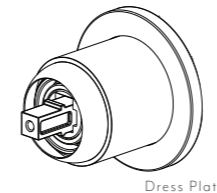

5 Push in the rubber gasket to mixer handle. Fasten the grub screw firmly with the allen key

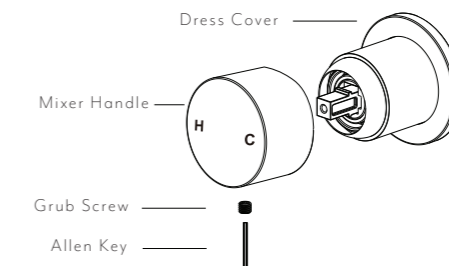

PROGRESSIVE MIXER OPERATION

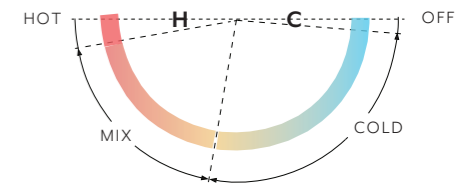

EXPLODED VIEW

- Item Description Code
- 1-2 Body
- 3 Back Plate
- 4 O-Ring
- 5 Cartridge
- 6 Locking Nut
- 7 Sleeve
- 8 Dome
- 9 Handle
- 10 Grub Screw
- 11 Cap
- 12 Fixing Screws
- 13 Protective Case
- 14 Allen Key

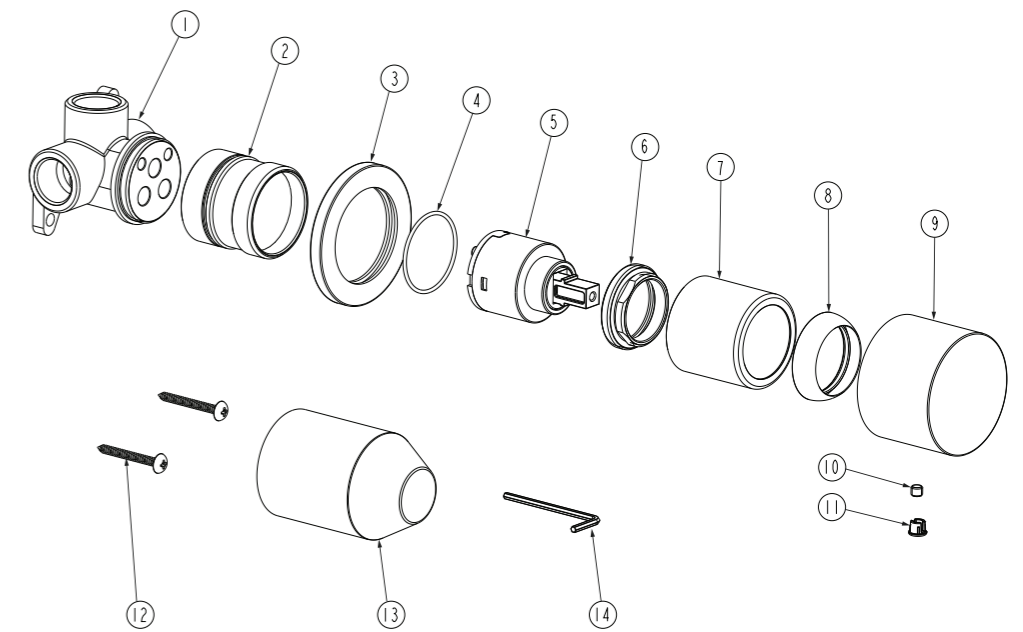

Regularly clean with mild liquid detergent or soap and water



DO NOT use cream cleaners or bleach. These substances are abrasive



DO NOT use cleaning pads with abrasive surfaces as this may scratch the material