

Note: Dimensions are nominal measurements only

SPECIFICATIONS

RECOMMENDED USE

Domestic

MATERIAL

Solid Brass

TEMPERATURE RATING

Maximum continuous working temperature 75°C
If the water temperature exceeds 75°C, an approved tempering valve must be fitted

PRESSURE RATING

Recommended minimum working pressure 150kPa
Recommended maximum working pressure 500kPa
Hot and cold water inlet pressure should be equal

STANDARDS

WELS 5 Star, 5.5L/min, T32352
(When paired with Milani Progressive Mixer)

Disclaimer: Products in this manual must by law be installed by licensed and registered tradespeople in accordance with the relevant standards. ABI and the manufacturer/distributor reserve the right to vary specifications or delete models from their range without prior notification. Dimensions are nominal measurements only. The information listed is correct at the time of publication, however ABI and the manufacturer/distributor takes no responsibility for printing errors. Copyright © ABI Interiors 2021

INSTALLATION GUIDE

Note: This product must be installed by a licensed tradesperson. This is a general installation guide - there are many factors that are involved that can alter the installation method. All work carried out must comply and be according to AS/NZS 3500.

- Slide the back plate onto the spout - make sure that the rubber is firmly in place to protect the spout and stop the back plate from moving around

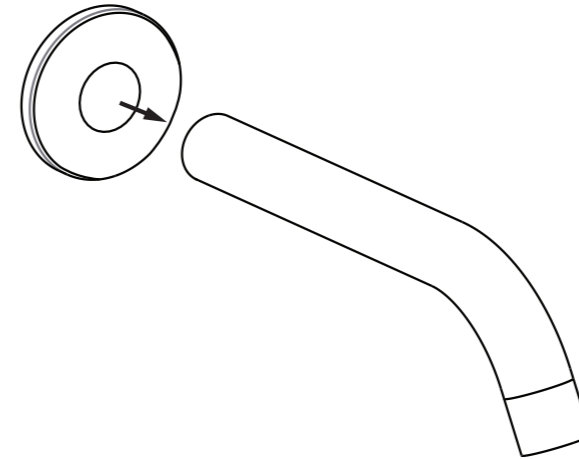

- Apply the teflon tape to the brass nipple. Twist the spout on and hand tighten.

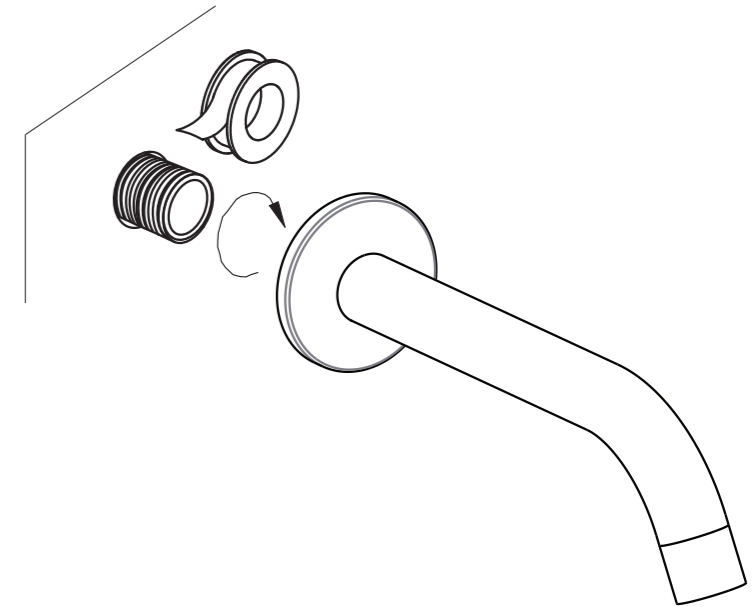

IN THE BOX

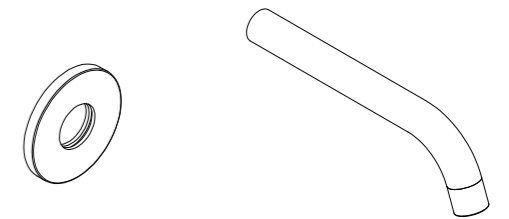

1x Back Plate

1x Spout



Regularly clean with mild liquid detergent or soap and water



DO NOT use cream cleaners or bleach. These substances are abrasive

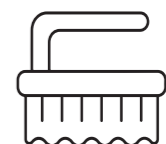

DO NOT use cleaning pads with abrasive surfaces as this may scratch the material

Just Colour Parts

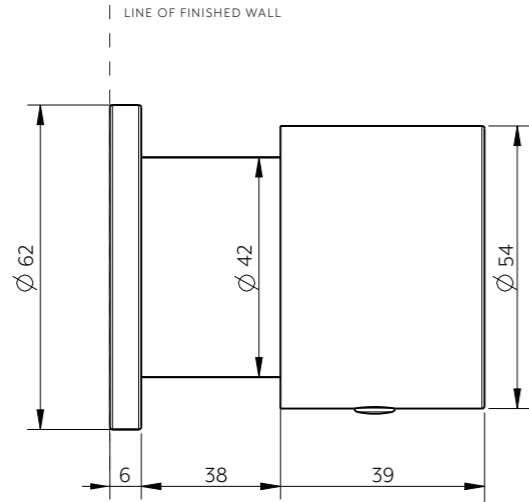

In Wall

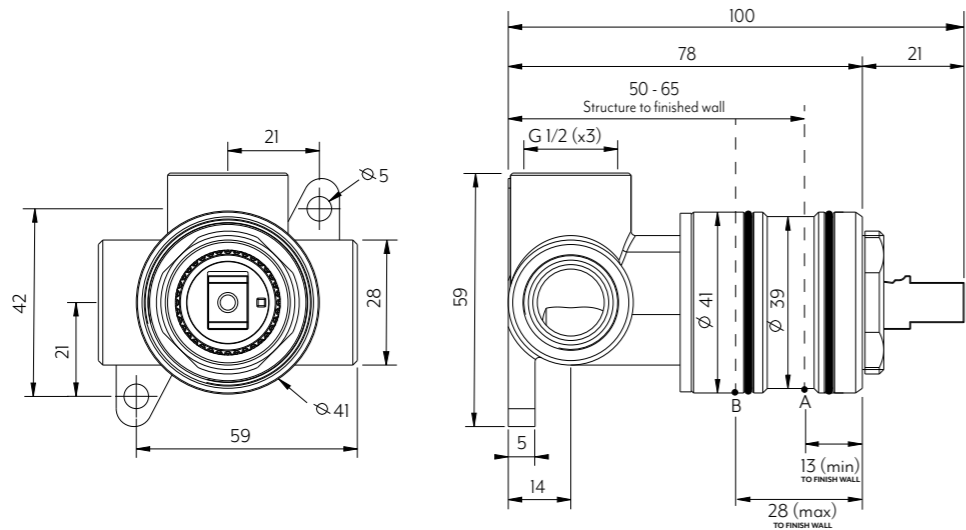

Disclaimer: To achieve Infiniti (interchangeable sleeves) finish wall must fall between Point A and B. Your In-Wall component must be installed without the sleeve attached, please ensure that your chosen sleeve doesn't break your waterproofing seal.

Note: Dimensions are nominal measurements only

SPECIFICATIONS

RECOMMENDED USE

Domestic

PRESSURE RATING

Recommended minimum working pressure 150kPa
Recommended maximum working pressure 500kPa
Hot and cold water inlet pressure should be equal

TEMPERATURE RATING

Maximum continuous working temperature 75°C
If the water temperature exceeds 75°C, an approved tempering valve must be fitted

SUITABLE HOT WATER UNITS

Storage tank: Yes
Continuous Flow: Yes
Gravity Feed: Not suitable

Disclaimer: Products in this specification manual must by regulation be installed by licensed and registered trade people. The manufacturer/distributor reserves the right to vary specifications or delete models from their range without prior notification. Dimensions are nominal measurements only. Dimensions and set-outs listed are correct at time of publication however the manufacturer/distributor takes no responsibility for printing errors. All ABI Products are designed in Australia. Copyright ABI Interiors Pty Ltd 2021.

INSTALLATION GUIDE

Note: This product must be installed by a licensed plumber. This is a general installation guide - there are many factors that are involved that can alter the installation method. This product install must comply with AS/NZS 3500.

- Fasten screws to secure the wall mixer into wall structure.
- Attach water supply and water outlet. **TEST AND CHECK FOR LEAKS.**
- Create a 47mm hole in cement sheet and tiles. Waterproof at this point if future sleeve change is desired. **DO NOT WATERPROOF SLEEVE.**
Please ensure that the hole is big enough to allow for the sleeve to slide on at fit-off stage.
- Push the sleeve over the body until it is as far back as possible and nut thread is exposed. Screw the dome onto the brass fitting and tighten.
- Place the handle onto the fitting. Fasten the grub screw firmly with the allen key.

HOW TO CUSTOMIZE YOUR MIXER

STEP 1: Visit our online shop or go in-store to purchase your handle kit - Be sure to check the mixer type before you purchase!

STEP 2: Remove the handle, dome and sleeve from your mixer & repeat steps above for installation! (Ensure waterproofing was conducted prior to sleeve install).

STEP 3: Be sure to get this checked by your plumber prior to using.

WHAT'S IN THE BOX EXPLODED VIEW

- Long Sleeve
- Dome
- Back Plate
- Handle
- Allen Key
- Short Sleeve

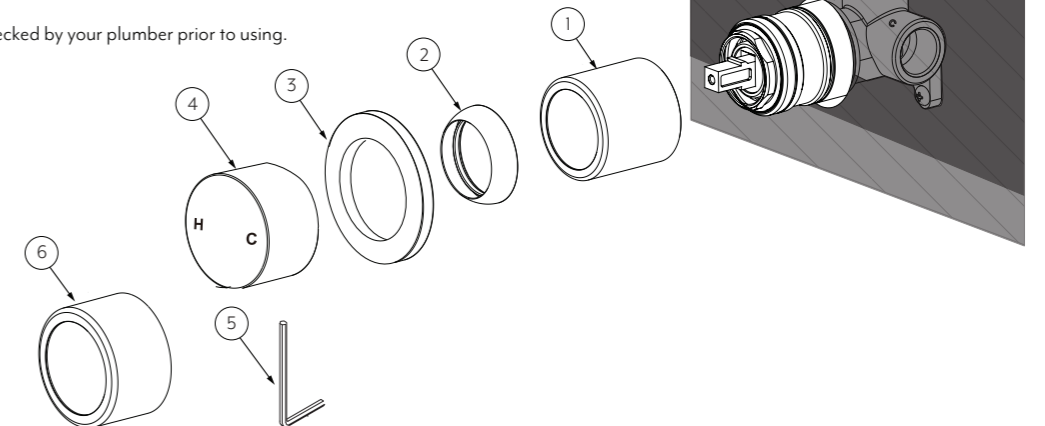

Regularly clean with mild liquid detergent or soap and water



DO NOT use cream cleaners or bleach. These substances are abrasive

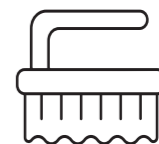

DO NOT use cleaning pads with abrasive surfaces as this may scratch the material