

ABI MYRA 3 DOOR MIRROR CABINET 1692MM

Recess Option

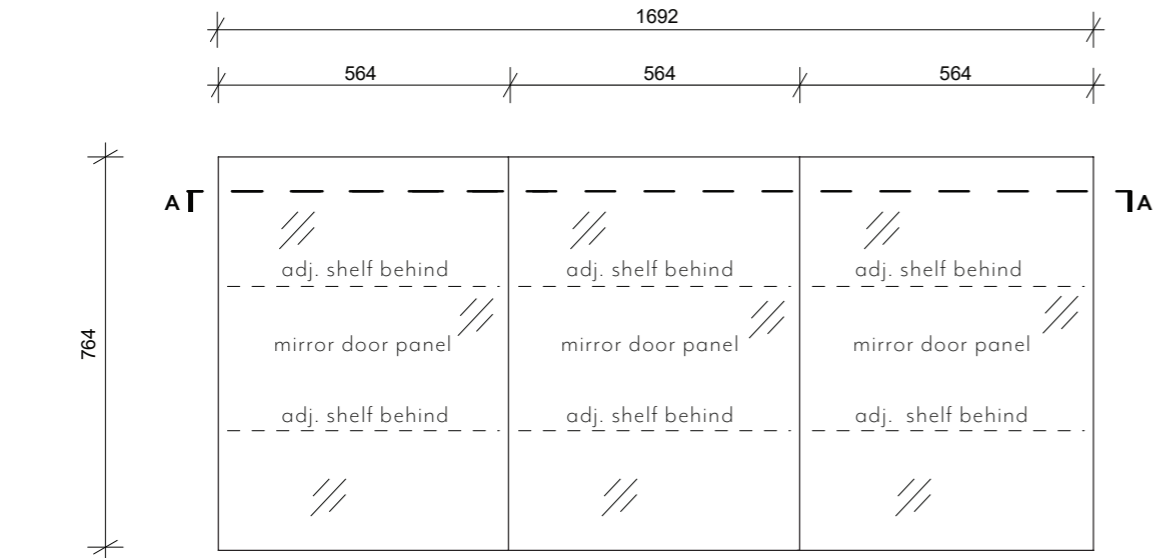

FRONT VIEW

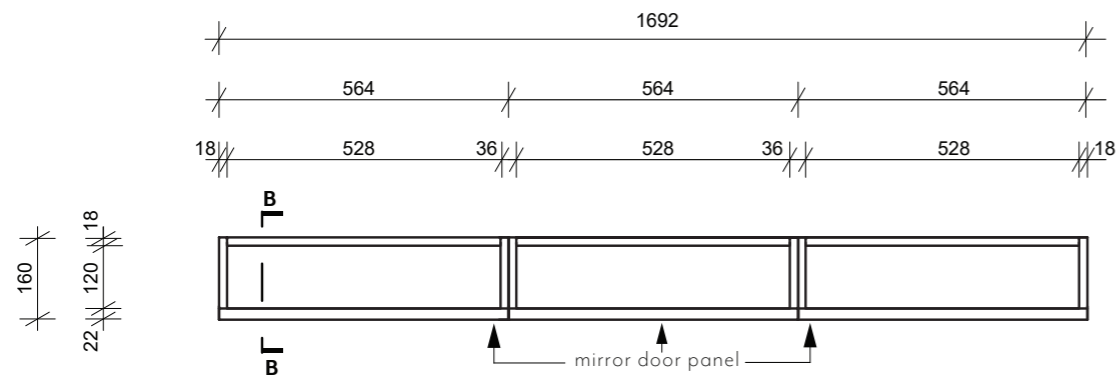

TOP SECTION AA

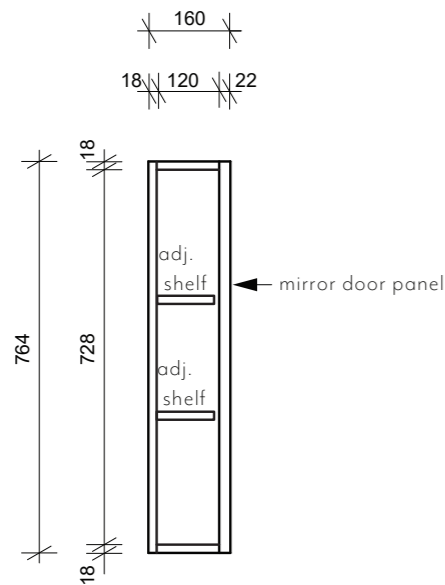

SIDE SECTION BB

Note: Dimensions are nominal measurements only

Disclaimer: Products in this specification manual must by regulation be installed by licensed and registered trade people. The manufacturer/distributor reserves the right to vary specifications or delete models from their range without prior notification. Dimensions are nominal measurements only. Dimensions and set-outs listed are correct at time of publication however the manufacturer/distributor takes no responsibility for printing errors. All ABI Products are designed in Australia. Copyright ABI Interiors Pty Ltd 2021.

INSTALLATION GUIDE

Note: This product must be installed by a licensed tradesperson. This is a general installation guide - there are many factors that are involved that can alter the installation method. The product shown in the installation guide may differ from the product purchased.

1 Check the desired height of mirror cabinet from floor.

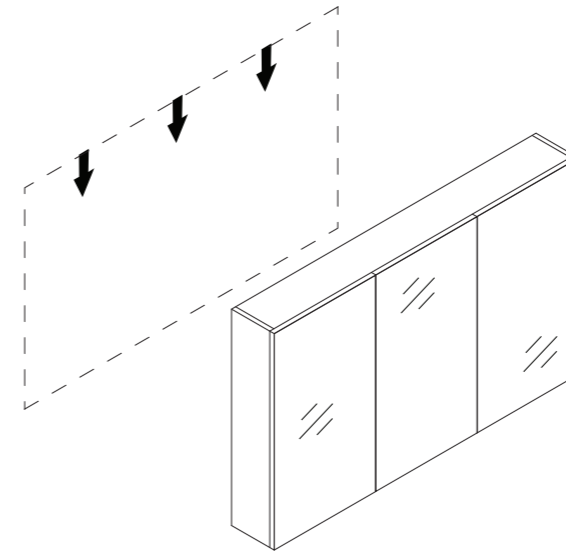

2 1. Provide framed niche into wall cavity as per overall cabinet dimension + wall lining thickness.
2. Finish framed niche opening with preferred internal wall lining.

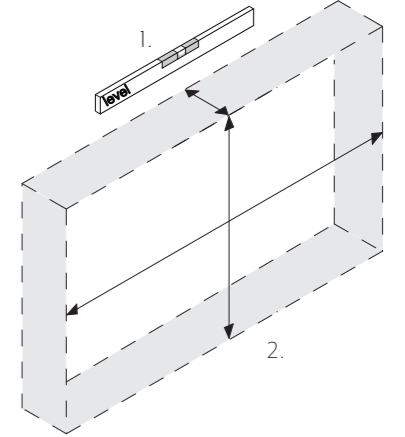

3 Insert cabinet into wall niche.
1. Drill holes through the mirror cabinet into structure within wall niche with wood drill bit.
2. Insert adjustable shelves.

Note: ensure adequate fixings are fixed into structure within wall. ABI takes no responsibility if vanity is not fixed into wall structure.

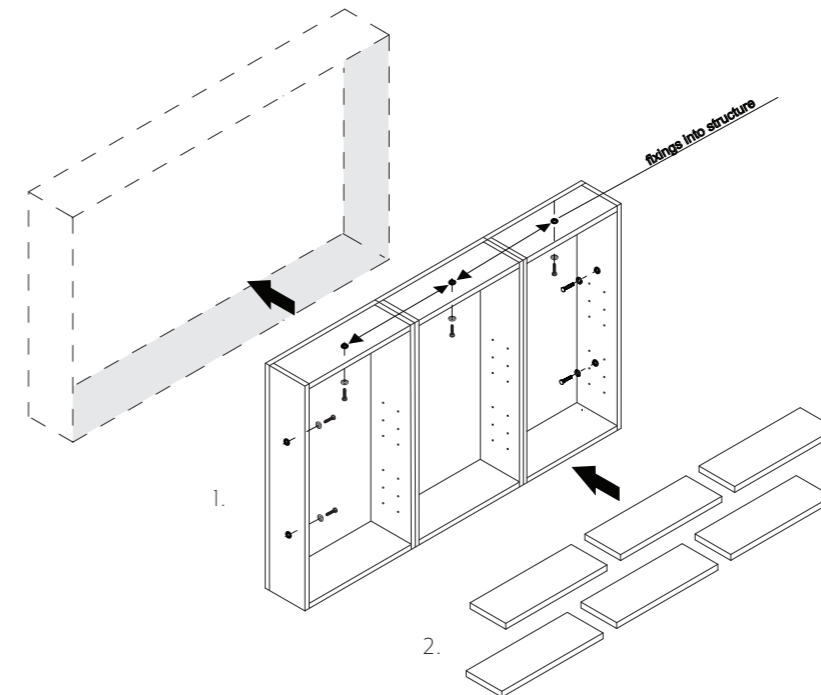

4 Silicone inset edge if necessary.
Note: may require door removal.

