

Top View

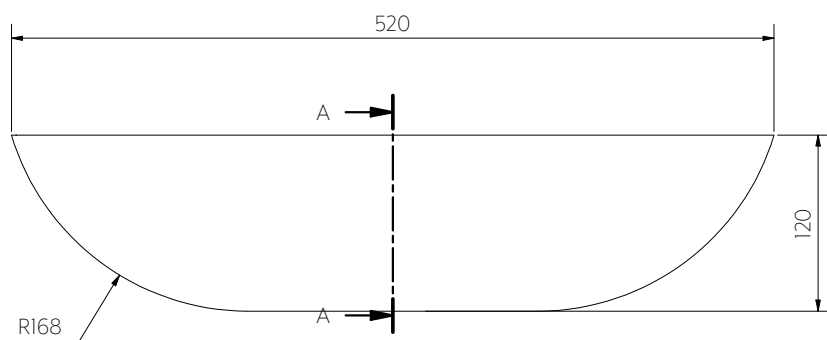

Front View

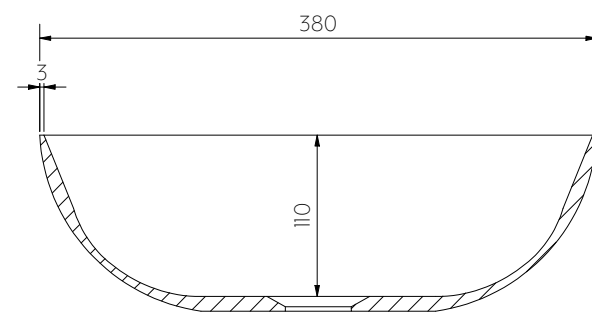

A-A

Note: Dimensions are nominal measurements only

SPECIFICATIONS

RECOMMENDED USE

Domestic

MATERIAL

Solid Surface

INSTALLATION

Bench Mount

OVERFLOW

No

CAPACITY

12.2L

RIM THICKNESS

3mm

Disclaimer: Products in this manual must by law be installed by licensed and registered tradespeople in accordance with the relevant standards. ABI and the manufacturer/distributor reserve the right to vary specifications or delete models from their range without prior notification. Dimensions are nominal measurements only. The information listed is correct at the time of publication, however ABI and the manufacturer/distributor takes no responsibility for printing errors. Copyright © ABI Interiors 2021

INSTALLATION GUIDE

Note: This product must be installed by a licensed plumber. This is a general installation guide - there are many factors that are involved that can alter the installation method. This product install must comply with AS/NZS 3500.

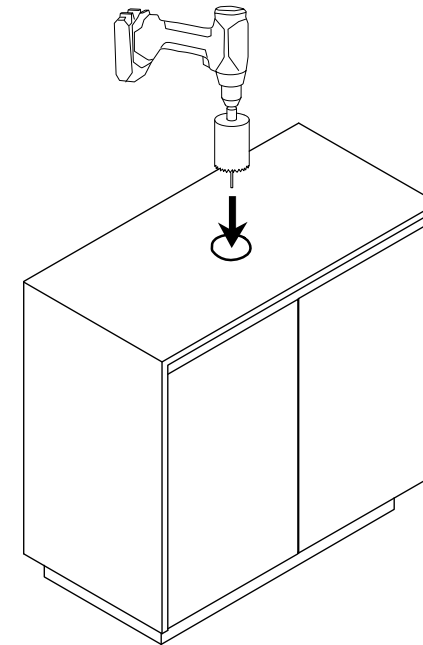

1 Mark out desired location of basin and drill hole for basin waste with a hole saw.

Note: If cutting a stone benchtop it will need to be cut in a controlled environment by a licensed tradesperson as per OH&S regulations.

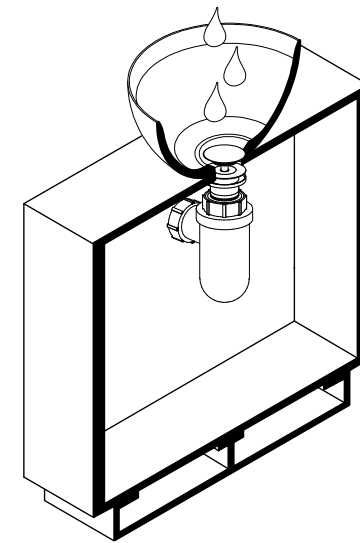

2 Install pop up waste and attach to plumbing. Test by running water through the waste and pushing the plug down.

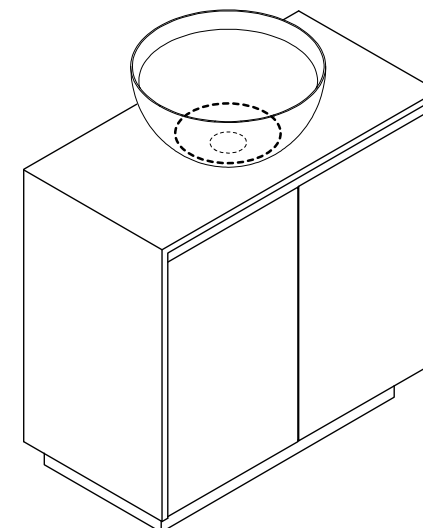

3 Silicone basin to vanity benchtop as required.



Regularly clean with mild liquid detergent or soap and water



DO NOT use cream cleaners or bleach. These substances are abrasive



DO NOT use cleaning pads with abrasive surfaces as this may scratch the material